

Data Sheet



Article number: 025799200104

Description: Norma Connect pipe coupling
GRIP E W4 Ø=104,6 EPDM, 16 bar

Measures

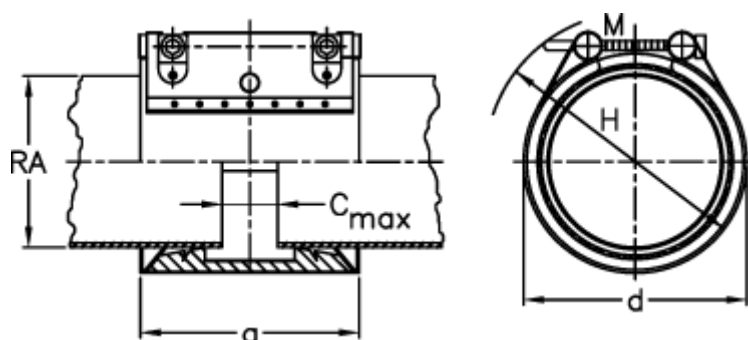

a	= 98
C max with insertion band	= 25
d	= 125
H	= 145
M (screw)	= M10
Nominal pressure (bar)	= 16
RA	= 104
RA min-RA max	= 102,9-105,1

Weight a piece = 1.7